

SYSTEM

EVB Brackets

2023.1

A unique Bracket System

- all components designed for a perfect system family
- ongoing development
- made of best materials
- most components in stock
- high volume production
- competitive prices

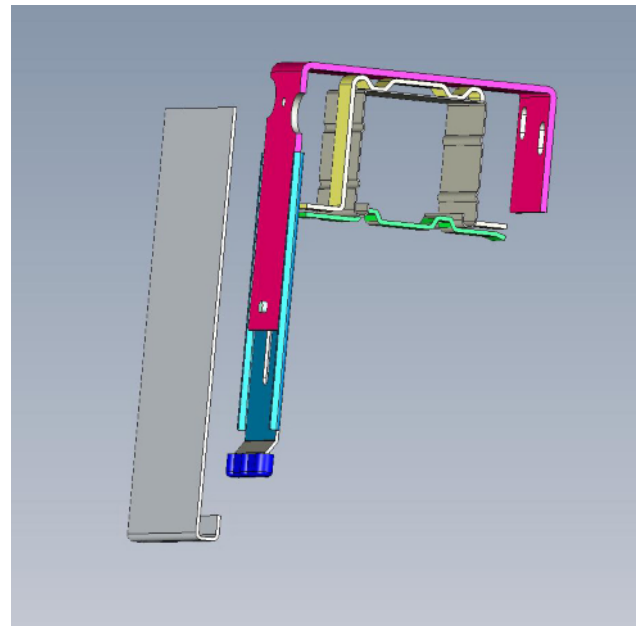
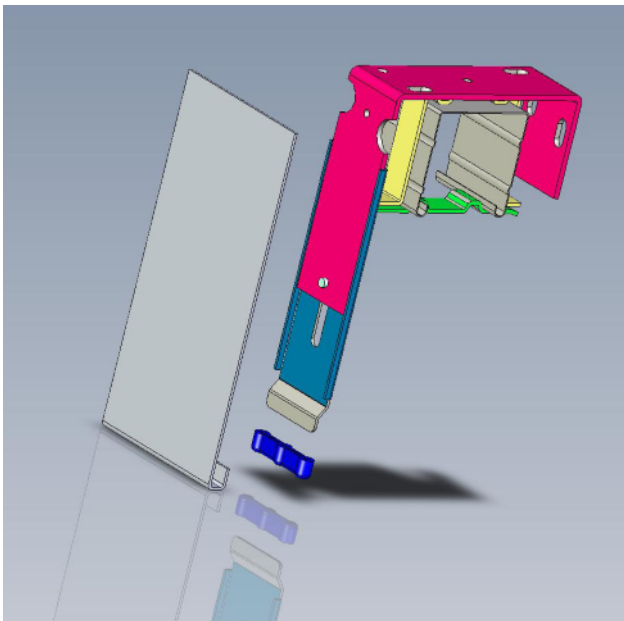

Head Rail Bracket

A wide variation of solutions.

Bracket hr 56x58, 2 screws

maximum flexibility with two screws

819 010

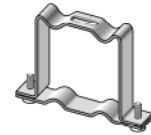

Bracket hr 56x58, 1 screw and 1 rivet

just one screw to tighten

819 011

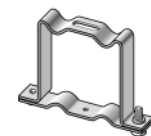

Bracket hr 56x58, auto-closing

with new Torx-head screws

820 113



Bracket hr 56x58, auto-closing with rubber

with noise reduction rubber and new Torx-head screws

820 114



Wall Bracket

A good solution, if no cover is needed.

Bracket 93mm, thickness 3mm

818 050

Bracket 138mm, thickness 4mm

818 055

Bracket 188mm, thickness 4mm

818 057

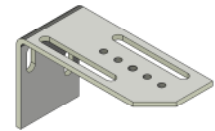

Special bracket 93mm, thickness 3mm

818 060

Special bracket 138mm, thickness 4mm

818 065

Special bracket 138mm, thickness **5mm**

818 066

Special bracket 188mm, thickness 4mm

818 067

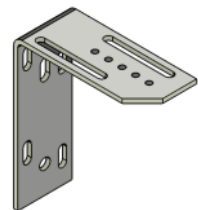

Bracket hr 56x58, 2 screws

819 010

Bracket hr 56x58, 1 screw/1 rivet

819 011

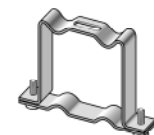

Bracket hr 56x58, auto-closing

820 113

Bracket hr 56x58, auto-closing with rubber

820 114



Standard Bracket

The most cost-effective solution for a bracket with cover.

Wall bracket 100mm
Wall bracket 120mm
Wall bracket 140mm

819 000
819 001
819 005

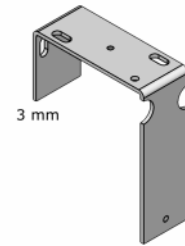

Wall bracket 120mm, extra strong 5mm
Wall bracket 140mm, extra strong 5mm

819 008
819 009

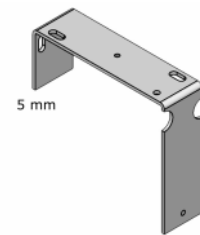

Bracket hr 56x58, 2 screws
Bracket hr 56x58, 1 screw/1 rivet

819 010
819 011

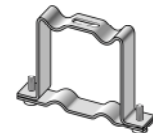

Bracket hr 56x58, auto-closing
Bracket hr 56x58, auto-closing with rubber

820 113
820 114



Extension 126mm cover height 130-173mm
Extension 143mm cover height 174-253mm
Extension 223mm cover height 254-330mm
Extension 303mm cover height 331-412mm
Extension 383mm cover height 473-480mm

819 015
819 020
819 025
819 030
819 035



Noise Reduction

819 039



Adjustable Bracket

The best solution for higher technical demand.

Adjustable wall bracket 100-150mm	818 100
Adjustable wall bracket 150-200mm	818 150
Adjustable wall bracket 200-250mm	818 170
Adjustable wall bracket 250-300mm	818 175

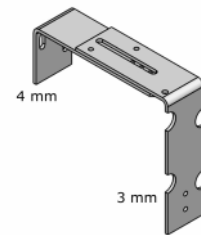

Adjustable wall bracket (5mm) 100-150mm	818 181
Adjustable wall bracket (5mm) 150-200mm	818 182
Adjustable wall bracket (5mm) 200-250mm	818 183
Adjustable wall bracket (5mm) 250-300mm	818 184

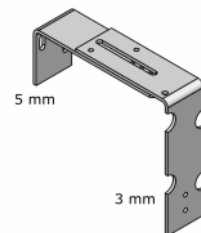

Bracket hr 56x58, 2 screws	819 010
Bracket hr 56x58, 1 screw/1 rivet	819 011

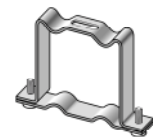

Bracket hr 56x58, auto-closing	820 113
Bracket hr 56x58, auto-closing with rubber	820 114



Distance plate	820 115
-----------------------	----------------



Extension 126mm , cover height 130-173mm	819 015
Extension 143mm , cover height 174-253mm	819 020
Extension 223mm , cover height 254-330mm	819 025
Extension 303mm , cover height 331-412mm	819 030
Extension 383mm , cover height 413-480mm	819 035



Noise Reduction	819 039
------------------------	----------------



Adjustable Bracket (special version) Perfect for an installation on thermo-isolated walls.

Adjustable wall bracket 100-150mm special	818 200
Adjustable wall bracket 150-200mm special	818 250
Adjustable wall bracket 200-250mm special	818 270
Adjustable wall bracket 250-300mm special	818 275

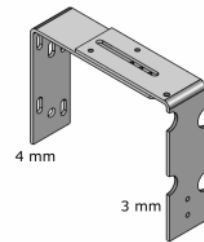

Adj. wall bracket (5mm) 100-150mm special	818 281
Adj. wall bracket (5mm) 150-200mm special	818 282
Adj. wall bracket (5mm) 200-250mm special	818 283
Adj. wall bracket (5mm) 250-300mm special	818 284

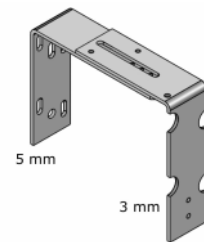

Bracket hr 56x58, 2 screws	819 010
Bracket hr 56x58, 1 screw/1 rivet	819 011

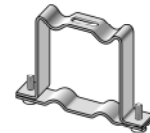

Bracket hr 56x58, auto-closing	820 113
Bracket hr 56x58, auto-closing with rubber	820 114



Distance plate	820 115
-----------------------	----------------



Extension 126mm , cover height 130-173mm	819 015
Extension 143mm , cover height 174-253mm	819 020
Extension 223mm , cover height 254-330mm	819 025
Extension 303mm , cover height 331-412mm	819 030
Extension 383mm , cover height 413-480mm	819 035

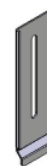

Noise Reduction	819 039
------------------------	----------------



Facade Bracket

Our "strongest" bracket made of 6mm steel.

