

SYSTEM

EVB Brackets

2018

A unique Bracket System

- all components designed for a perfect system family
- ongoing development
- made of best materials
- most components in stock
- high volume production
- competitive prices

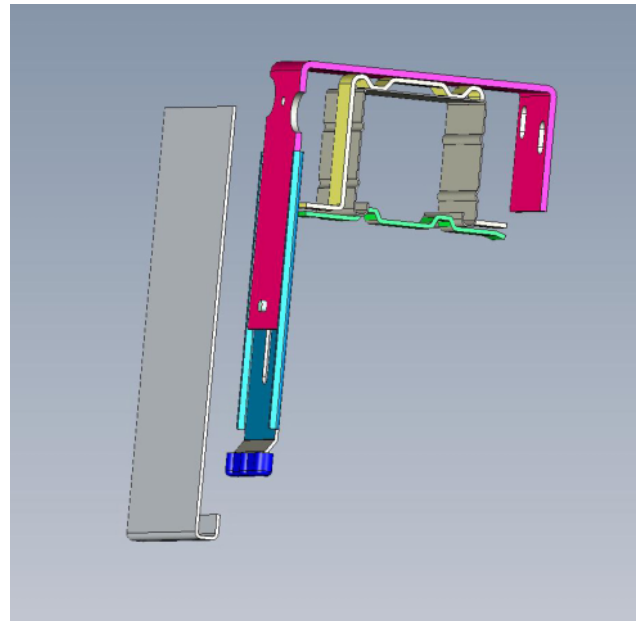
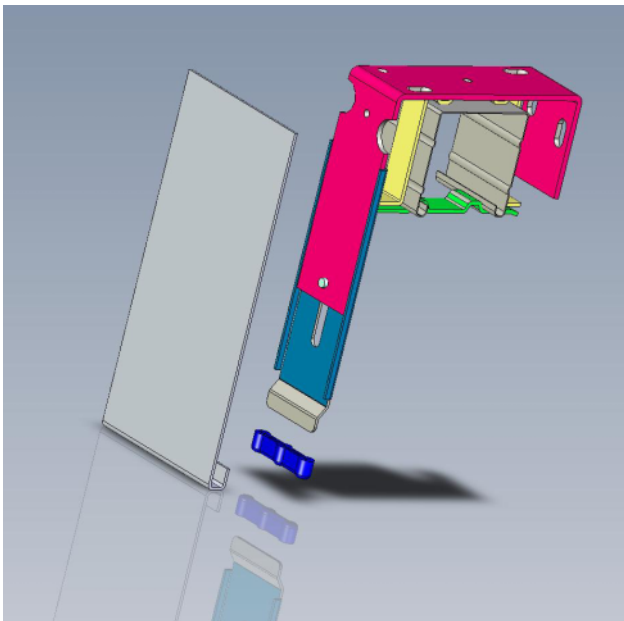

Wall Bracket

A good solution, if no cover is needed.

Bracket 93mm, thickness 3mm

818 050

Bracket 138mm, thickness 4mm

818 055

Bracket 188mm, thickness 4mm
(steel, zinc plated)

818 057

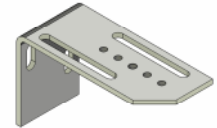

Special bracket 93mm, thickness 3mm

818 060

Special bracket 138mm, thickness 4mm

818 065

Special bracket 138mm, thickness 5mm

818 066

Special bracket 188mm, thickness 4mm
(steel, zinc plated)

818 067

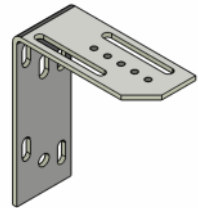

Bracket hr 56x58, 2 screws

819 010

Bracket hr 56x58, 1 screw/1 rivet

819 011

Bracket hr 51x57, 2 screws

819 013

(steel, zinc plated)

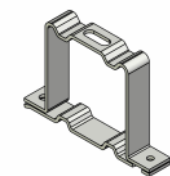

Standard Bracket

The most cost-effective solution for a bracket with cover.

Wall bracket 100mm
Wall bracket 120mm
Wall bracket 140mm
 (steel 3mm, zinc plated)

819 000
819 001
819 005

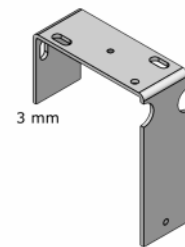

Wall bracket 120mm, extra strong 5mm
Wall bracket 140mm, extra strong 5mm
 (steel 5mm, zinc plated)

819 008
819 009

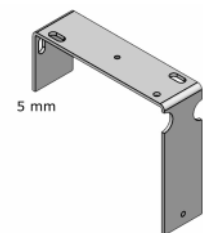

Bracket hr 56x58, 2 screws
Bracket hr 56x58, 1 screw/1 rivet
Bracket hr 51x57, 2 screws
 (steel, zinc plated)

819 010
819 011
819 013

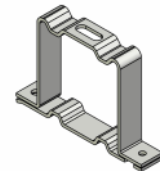

Extension 126mm cover height 130-173mm
Extension 143mm cover height 174-253mm
Extension 223mm cover height 254-330mm
Extension 303mm cover height 331-412mm
Extension 383mm cover height 473-480mm
 (steel, zinc plated)

819 015
819 020
819 025
819 030
819 035



Noise Reduction
 (plastic, black)

819 039



Adjustable Bracket

The best solution for higher technical demand.

Adjustable wall bracket 100-150mm
Adjustable wall bracket 150-200mm
Adjustable wall bracket 200-250mm
Adjustable wall bracket 250-300mm
 (steel, zinc plated)

818 100
818 150
818 170
818 175

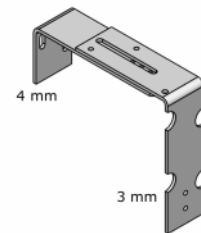

Adjustable wall bracket (5mm) 100-150mm
Adjustable wall bracket (5mm) 150-200mm
Adjustable wall bracket (5mm) 200-250mm
Adjustable wall bracket (5mm) 250-300mm
 (steel, zinc plated)

818 181
818 182
818 183
818 184

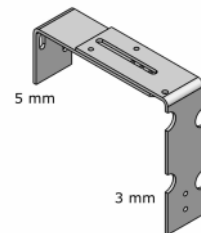

Bracket hr 56x58, 2 screws
Bracket hr 56x58, 1 screw/1 rivet
Bracket hr 51x57, 2 screws
 (steel, zinc plated)

819 010
819 011
819 013

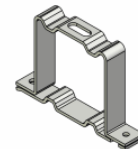

Distance plate
 (plastic)

820 115



Extension 126mm, cover height 130-173mm
Extension 143mm, cover height 174-253mm
Extension 223mm, cover height 254-330mm
Extension 303mm, cover height 331-412mm
Extension 383mm, cover height 413-480mm
 (steel, zinc plated)

819 015
819 020
819 025
819 030
819 035

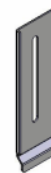

Noise Reduction
 (plastic, black)

819 039



Adjustable Bracket (special version)

Perfect for an installation on thermo-isolated walls.

Adjustable wall bracket 100-150mm special 818 200
Adjustable wall bracket 150-200mm special 818 250
Adjustable wall bracket 200-250mm special 818 270
Adjustable wall bracket 250-300mm special 818 275
 (steel, zinc plated)

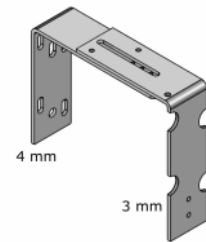

Adj. wall bracket (5mm) 100-150mm special 818 281
Adj. wall bracket (5mm) 150-200mm special 818 282
Adj. wall bracket (5mm) 200-250mm special 818 283
Adj. wall bracket (5mm) 250-300mm special 818 284
 (steel, zinc plated)

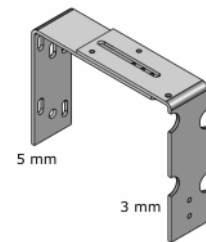

Bracket hr 56x58, 2 screws 819 010
Bracket hr 56x58, 1 screw/1 rivet 819 011
Bracket hr 51x57 2 screws 819 013
 (steel, zinc plated)

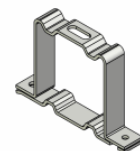

Distance plate 820 115
 (plastic)



Extension 126mm, cover height 130-173mm 819 015
Extension 143mm, cover height 174-253mm 819 020
Extension 223mm, cover height 254-330mm 819 025
Extension 303mm, cover height 331-412mm 819 030
Extension 383mm, cover height 413-480mm 819 035
 (steel, zinc plated)



Noise Reduction 819 039
 (plastic, black)



Facade Bracket

Our “strongest” bracket made of 6mm steel.

